

AgieCharmilles

# FORM S 350

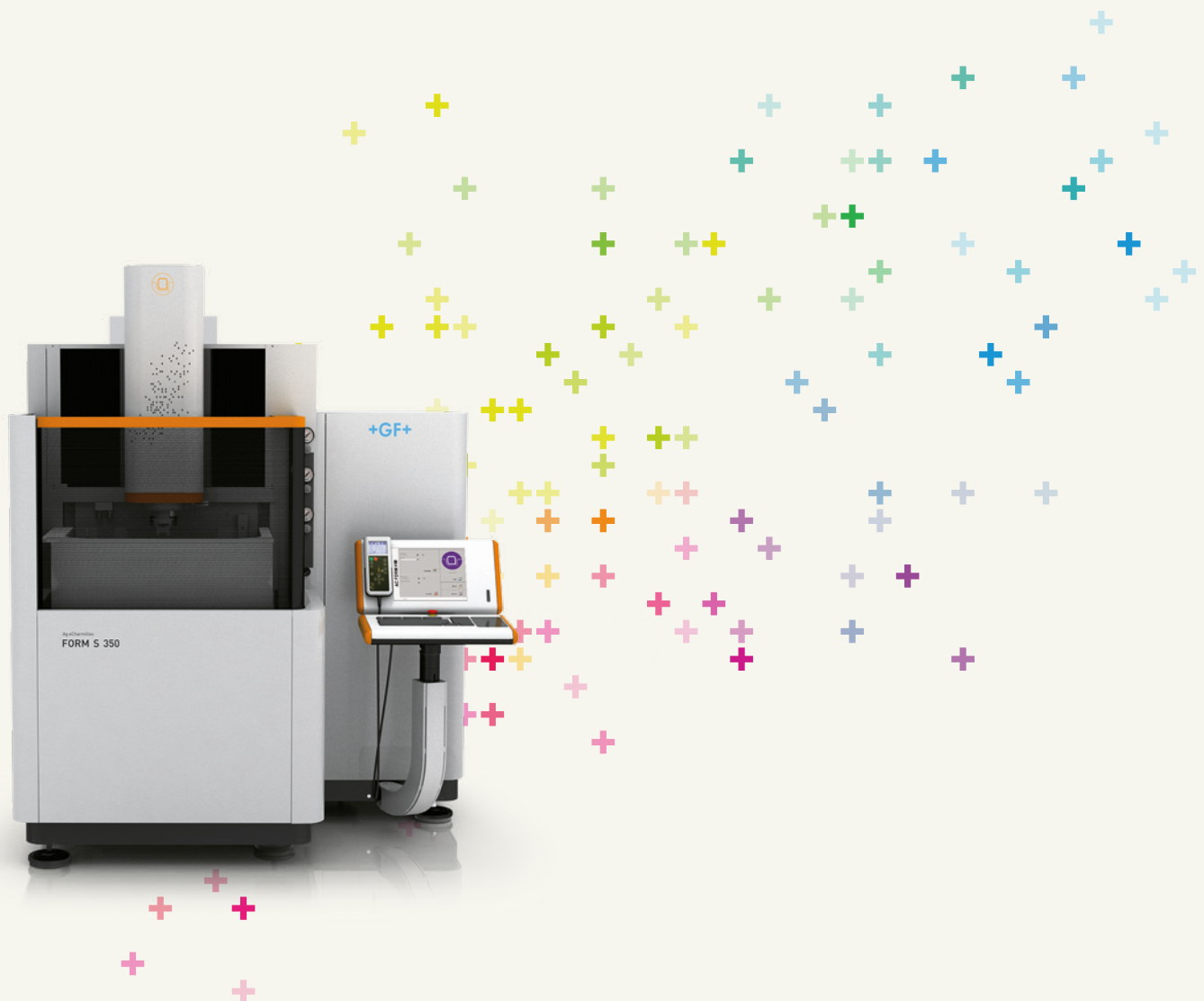

### **GF Machining Solutions: all about you**

When all you need is everything, it's good to know that there is one company that you can count on to deliver complete solutions and services. From world-class electrical discharge machines (EDM), Laser texturing and Additive Manufacturing through to first-class Milling and Spindles, Tooling, Automation and software systems — all backed by unrivalled customer service and support — we, through our AgieCharmilles, Microlution, Mikron Mill, Liechti, Step-Tec and System 3R technologies, help you raise your game and increase your competitive edge.

# Passion for Precision

# Contents

Electronic components	4
Your miniaturization solution	6
Boost your productivity	7
Innovative hardware to boost your quality	8
Innovating to deliver perfection	9
A unique mechanical base	10
State-of-the-art Swiss assembly	11
Thermostabilization	12
Application-securing know-how	14
The right Milling solution	16
Higher degree of autonomy	18
Customer Services	19
Technical specifications	20
GF Machining Solutions	22

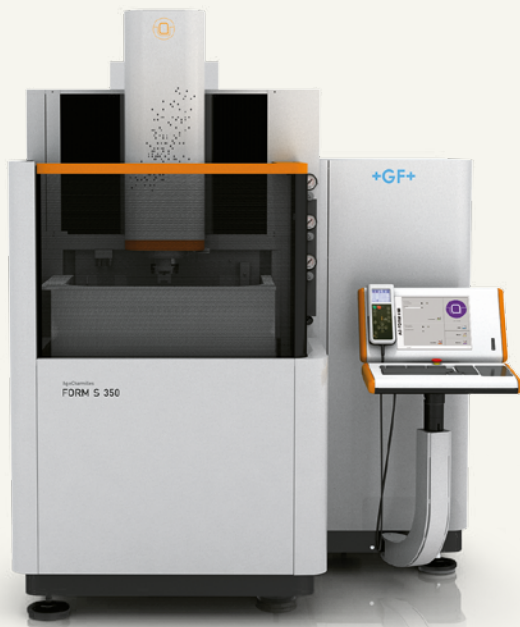

## Connecting you to success

Perfectly master the  $\mu\text{m}^3$  world and fulfill the needs of your customers in electronic component manufacturing. The FORM S 350 has your micro machining applications covered.

## Electronic components

# Connecting to success

Easily—and with extreme repeatability—deliver the perfect machining accuracy your customers demand. From medtech to automotive to manufacturing processes, ours is increasingly connected world, with electronics becoming ever smarter and making life more efficient and comfortable. Electronic component manufacturers require performant, high-quality and cost-effective electronic components. Position your business to meet manufacturers' quality requirements with the high-precision FORM S 350's state-of-the-art design, onboard power generation system, accuracy-enhancing stability and thermostabilization, and success-boosting machining quality.



### Accuracy to boost your production quality

- Extraordinary surface finish
- Ultimate accuracy and respect for details
- Use micro profiles down to a few microns

### Optimal performance—right out of the box

Smallest gap in automatic mode  
down to a few microns

### Economical electrode use

Lower electrode consumption per part,  
thanks to hardware optimization



### Drive to success

The automotive industry is investing heavily in electronics and has taken its place in the fast lane when it comes to connectivity. Connected cars already are available and generating significant revenues for car makers and technology companies.

By 2020, intelligent cars will be a major contributor to electronic component industry growth: Most cars shipped globally will have the hardware to stream music, look up movie times, generate traffic and weather alerts, and even power driver-assistance services like self parking.

### A growing market trend

The global electronic components market is projected to grow significantly in the coming years to satisfy demands.

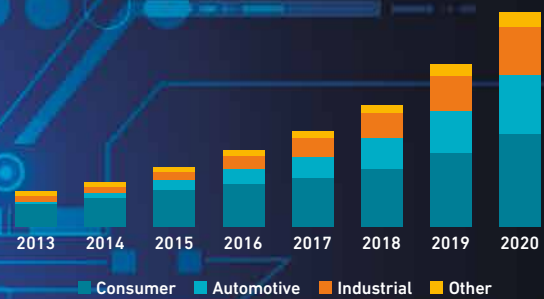

Your miniaturization solution

# Connect to the world of precision

Take your mass production of multi-cavity molds to new levels of productivity and quality to overcome the miniaturization challenges in today's fast-moving electronic components marketplace. Extraordinarily small part dimensions demand highest mold accuracy in mass production of multi-cavity molds, and this solution delivers highest accuracy and more. You'll achieve best productivity in terms of machining time while enjoying superior surface finish, high geometrical and positioning accuracy, and fewer defective parts with the FORM S 350.

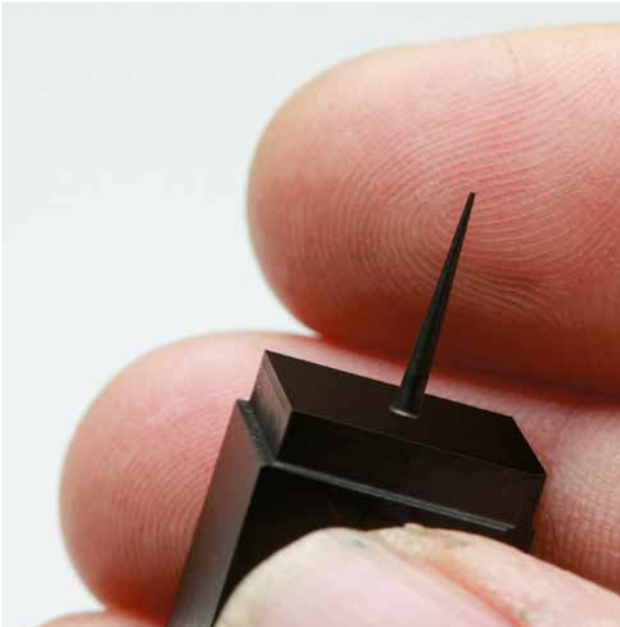

## Step into the world of micro profiles

Smaller profiles—down to 50 microns—are now at your fingertips, thanks to the FORM S 350's onboard technologies for machining tiny details.

## Perfect details—every time

Machine those perfect details with absolute confidence, thanks to the stable micro-spark machining process adapted to your specific micro applications. With the automatically generated small sparks delivered by this solution, you'll machine perfect details—right off the bat.

## Sharpest results to meet your application demands

Reduce electrode wear by up to 50 percent and confidently machine the tiny radii required in electronic component manufacturing, thanks to the micromachining technology of this solution's latest-generation Intelligent Speed Power Generator (ISPG).

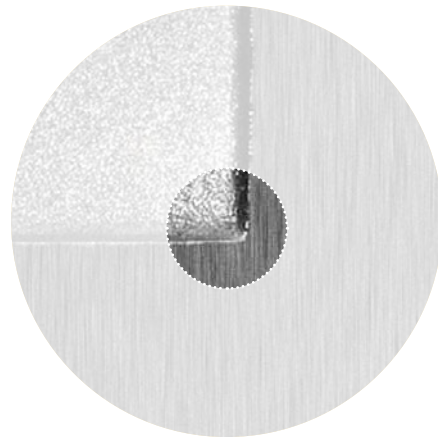

Perfect micro radii—every time

Boost your productivity

# Optimize your micromachining process

Consuming fewer electrodes has a positive impact on your bottom line, and the new embedded technology of the FORM S 350 significantly decreases the number of electrodes required for your processes. Experience the shorter machining times and reduced downtime that come with fewer electrode changes.

## Extended life of multi-pitch electrodes

High-precision multi-pitch electrodes are costly to produce. That's why we optimize their use to yield the most precise results with maximum respect for details—in an economical way.

## Greater productivity with Customer Services

The right electrode choice will have a big impact on your productivity. We are the right partner to optimize your machining process with, for example, combinations of graphic and copper electrodes as well as dielectric.

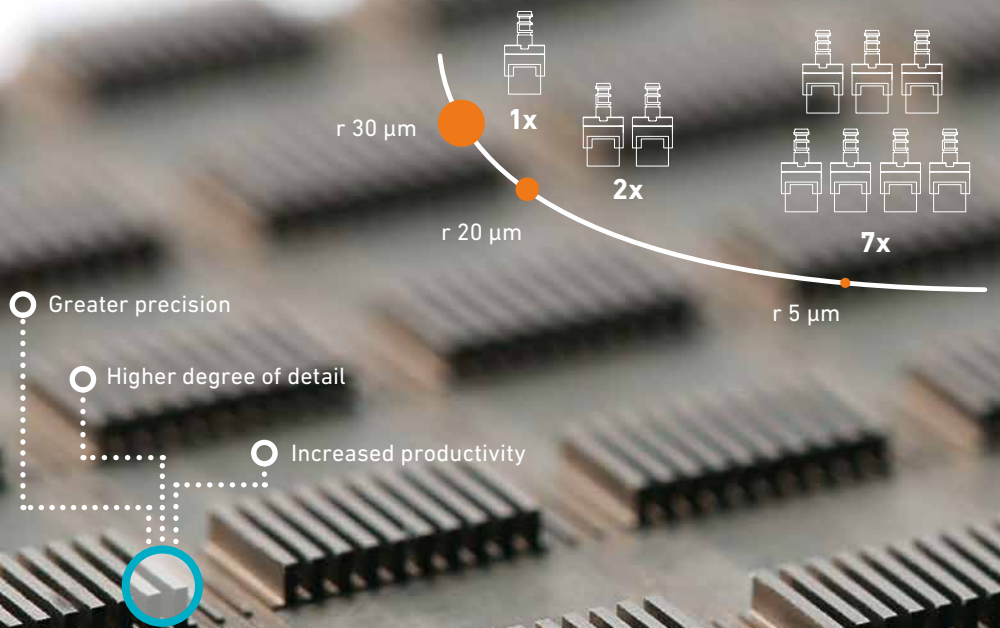

Innovative hardware to boost your quality

# Master details for impeccable geometrical quality

Cost-effectively achieving the extraordinary fineness of detail on the smaller molds required for your customers' finished products is at the heart of the FORM S 350. This solution simplifies micromachining of highly detailed geometries—even in mass production—thanks to new features to enhance your precision, speed and productivity.



## Closer to the part, closer to perfection

Consume fewer electrodes while achieving greater geometrical accuracy and productivity with the FORM S 350's Intelligent Speed Power Generator (ISPG). Situated close to the part, the generator optimizes machining efficiency by allowing you to eliminate any issues due to lost power.

## Advantages on final parts

- Follow miniaturization trend
- Better part assembly process



Innovating to deliver perfection

# Reach unprecedented levels of quality

Ramp up your efficiency and quality, thanks to this machine's new discharge circuit allowing spark erosion power modulation and the flexibility to maximize material removal. Achieve greater finishing detail by reducing the gap to a few microns. You'll achieve higher machining yields while preserving electrode geometry, due to an extremely low rate of electrode wear.

## Our miniaturization solution—from the very first spark

We control the spark to reduce the number of electrodes you need, so your productivity is accelerated and you achieve the smaller radii essential to the production of tools for miniature electronic components.

In super finishing, the discharge energy is accurately modulated, so you attain finer surface quality, shape accuracy and reproduction of details. That's a real plus in applications like production of connector molds for electronics.

## New generator

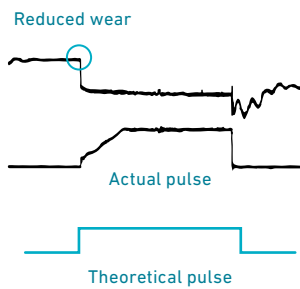

## Re-openings

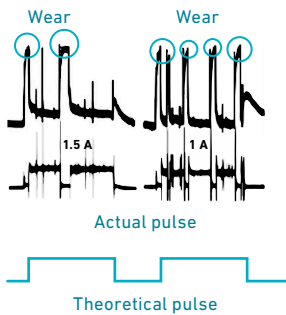

Avoid the problems arising from standard power generators' power reopening in the high finishing die-sinking process. The FORM S 350's supreme spark control eliminates interruption of the discharge and subsequent exponential increases in electrode wear.

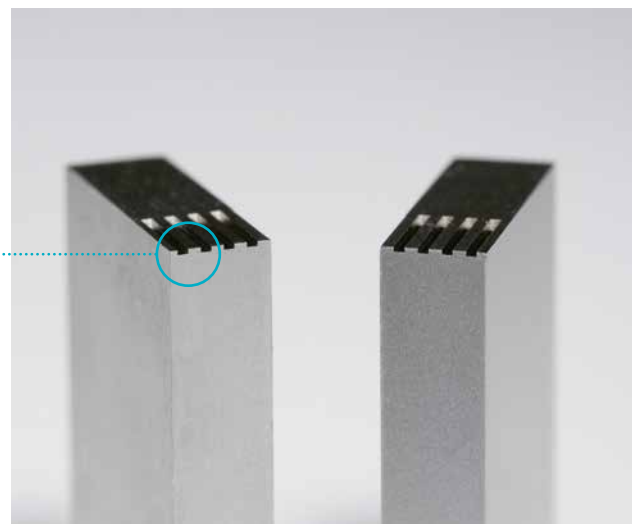
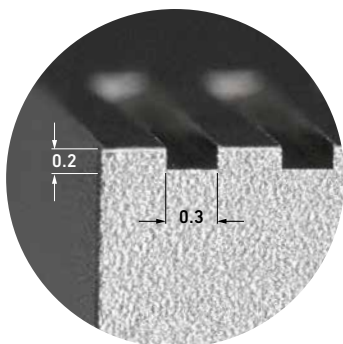

A unique mechanical base

# Made to help you master accuracy

Engineered to ensure highest repeatable precision, this solution is your foundation for machining stability in the production of electronic components. With the FORM S 350's stability, you will deliver reliably high quality to your customers and ensure the perfection of their end products.

## Optimal machining stability

Experience superior mechanical stability and precision across the life of the machine, thanks to its short C-axis construction and oversize cast iron frame. As a result, your accuracy is uncompromised by part weight or dielectric volume. Your precision is further advanced by this solution's robust construction absorbing all machining forces, so a precise gap between your part and electrode is maintained.

## Perfect repeatability to lower your unproductive time

Experience the lasting positioning precision that only linear glass scales can guarantee. They eliminate classical errors like inversion-induced play, expansion and wear effects. At the same time, the need for periodic maintenance and calibration is eliminated by our dual loop positioning system, a closed-loop measuring system providing infallible precision, whatever the travel.

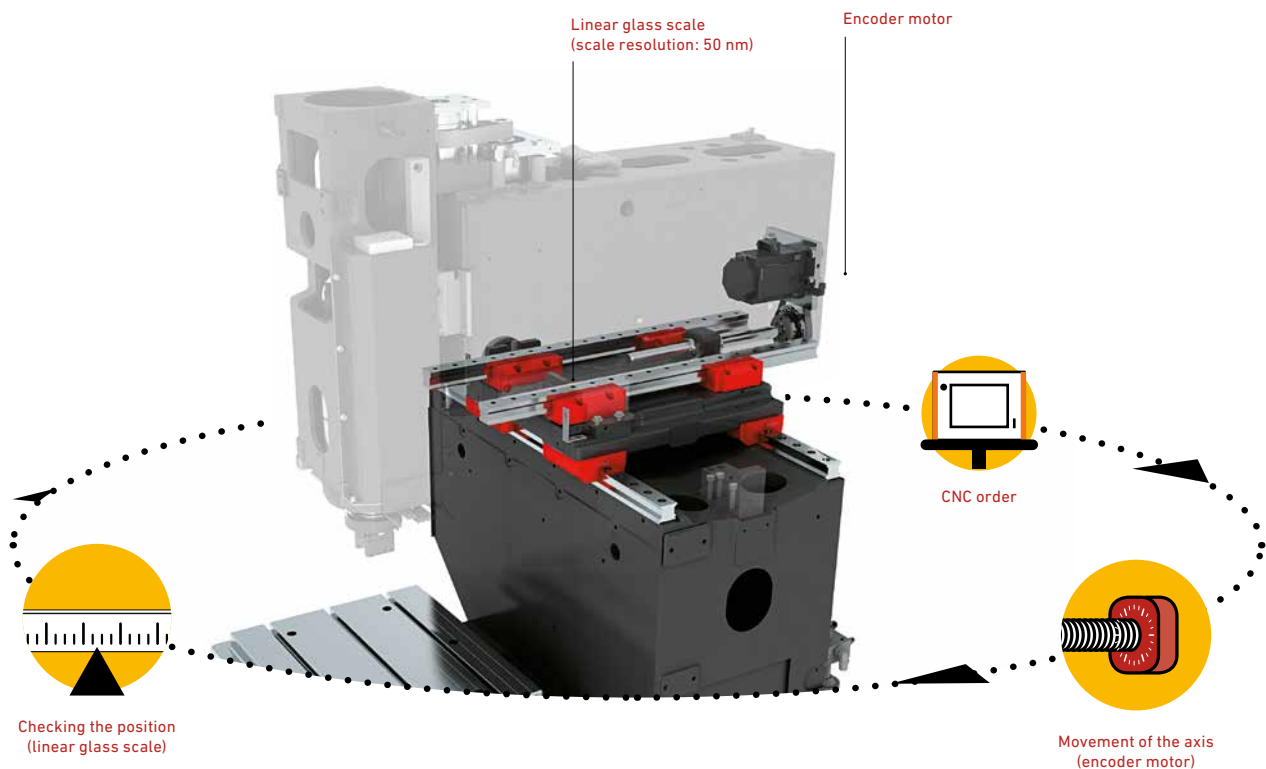



State-of-the-art Swiss assembly

# Achieve perfect accuracy to meet highest requirements

You demand perfection from our machine tools and we demand perfection in their assembly. Swiss precision is an anchor of GF Machining Solutions production.

## **Quality assurance for your incomparably consistent production**

Production consistency is a must-have across your global machine fleet and we give you the high-quality tools to bring predictably reliable performance to life. You can bank on our 60-plus year legacy of delivering globally consistent production quality aligned with unbeatable Swiss precision.

## **Our service experts at your side**

Experience long-term, stable performance with us at your side throughout the whole life cycle of your machines. Our preventive maintenance program can be tailored to your needs, depending on the constraints of your market or your requirements in terms of accuracy or repeatability.

## Thermostabilization

# Stable machining conditions to achieve optimal precision

Workshop temperature fluctuations won't impact your part machining precision, thanks to the FORM S 350's dual thermostabilization system—a major innovation when working close to micron dimensions. Pulsating air circulates in the cabin and is cooled in real time in accordance with the dielectric temperature and is measured by a double, differential thermal probe. Similarly, the full structure of the X, Y and Z axes is thermostabilized.

### The principle of double thermostabilization

Consistent, continuous mechanical stability is the hallmark of this solution's thermostabilization system—a world first that keeps temperature variations from impacting your part machining. Making this unparalleled stability possible are an air-conditioned cabin and cooled dielectric circulation through the work table.

#### Dielectric

- 1 Thermostat allowing dielectric temperature regulation
- 2 Water/dielectric heat exchanger
- 3 Dielectric circulation is an integral part of the table

#### Air

- 4 Double temperature-probe thermostat allowing adjustment of air temperature to that of the dielectric
- 5 Water/air heat exchanger
- 6 Coolant liquid electrovalve

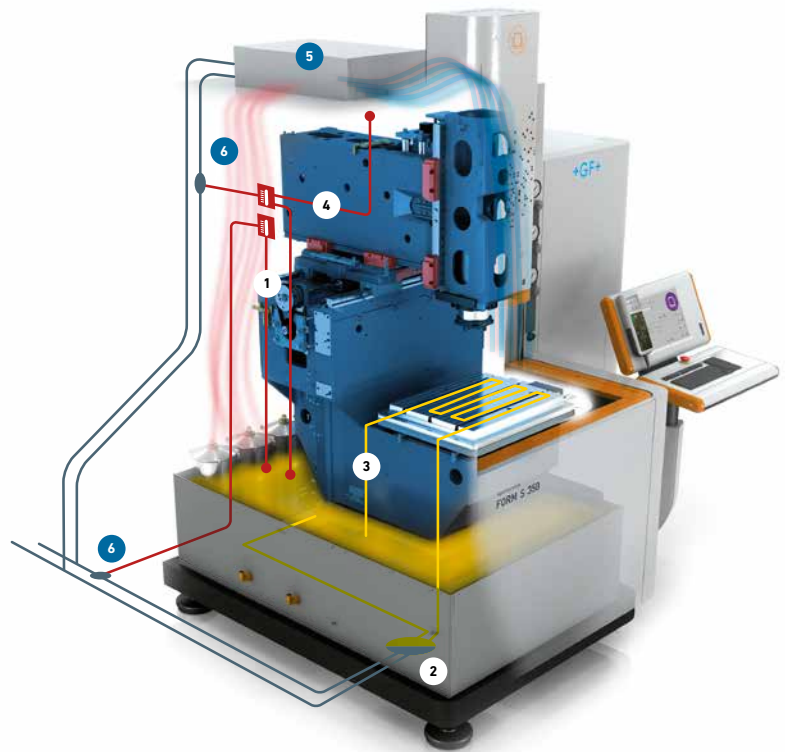

Comparative analysis of axis drift between machines with and without thermostabilization.

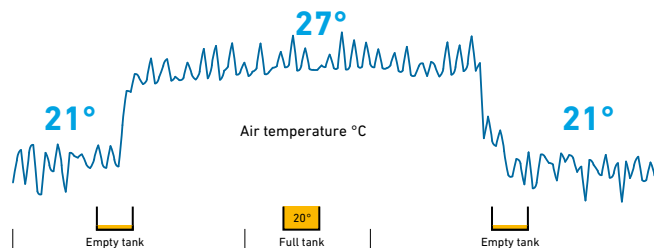

- XYZ deviation with thermostabilization
- XYZ deviation without thermostabilization
- Temperature variation

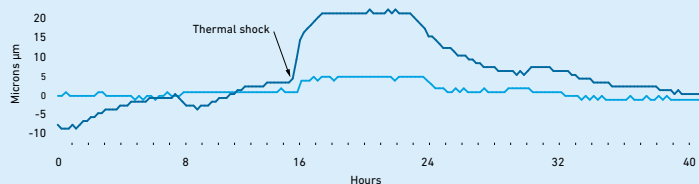



# A stable cornerstone for advanced precision

Flawless finished product quality is ensured by a temperature recording device that continuously displays the overall level of thermostabilization.

Application-securing know-how

# Boost your operations

Achieve best-in-class results with ease. As your micromachining application champion the FORM S 350 pairs precision and ease of use to take the complexity out of your production.

## Maintain machining conditions whatever the depth

Easily machine small, deep cavities—whatever their depth—while maintaining optimal machining conditions, due to GF Machining Solutions' specially adapted technology.

## Cut consumables costs and get higher consistency

Boost your productivity with our wear partitioning technology adjusting your power, motion and electrode change. By helping you automatically generate the most effective machining strategy, wear partitioning simplifies your management of electrode wear on jobs involving multiple cavities with similar dimensions, tolerances and surface finishes.



## Automate your operations and boost your business

Get an extensive selection of machining technologies to cover the vast majority of your micro applications with this solution's human-machine interface (HMI). AC FORM HMI automatically generates the machining strategies you need based on data entered by your operator. Progressive power stages to increase machining efficiency according to the electrode's sub-miniature geometry are managed by the HMI without altering that geometry.

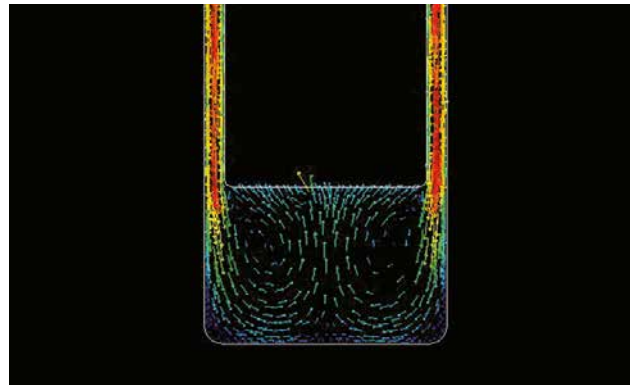

## Get better particle evacuation to ease your production

This technological choice from GF Machining Solutions, in comparison to linear motors, facilitates evacuation of particles in cavities, thanks to the pulsation speed, without flushing and without deformation of the cavity. This is a distinct plus for applications such as connector technology, ribs or micro-machining. For machining deep ribs, high pulsation rates for better particle evacuation are required.

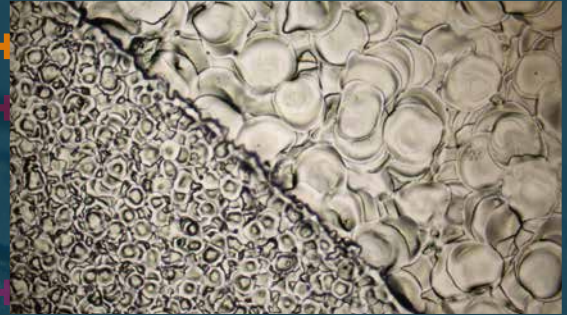
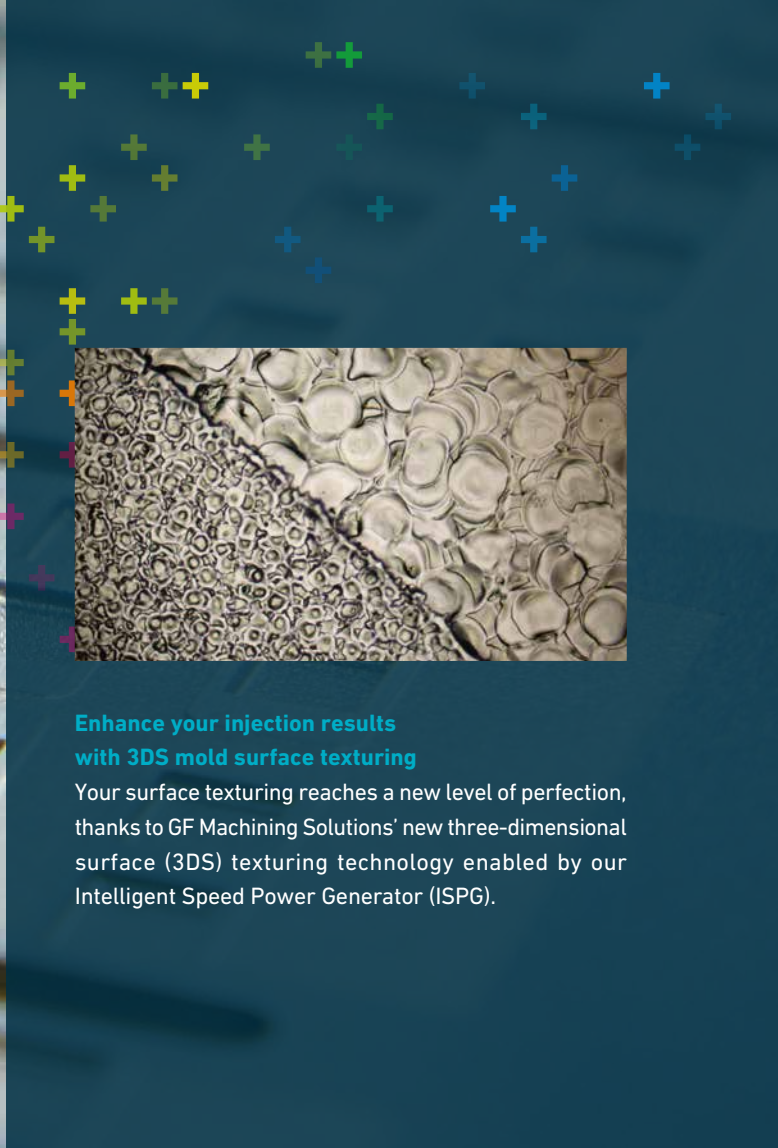
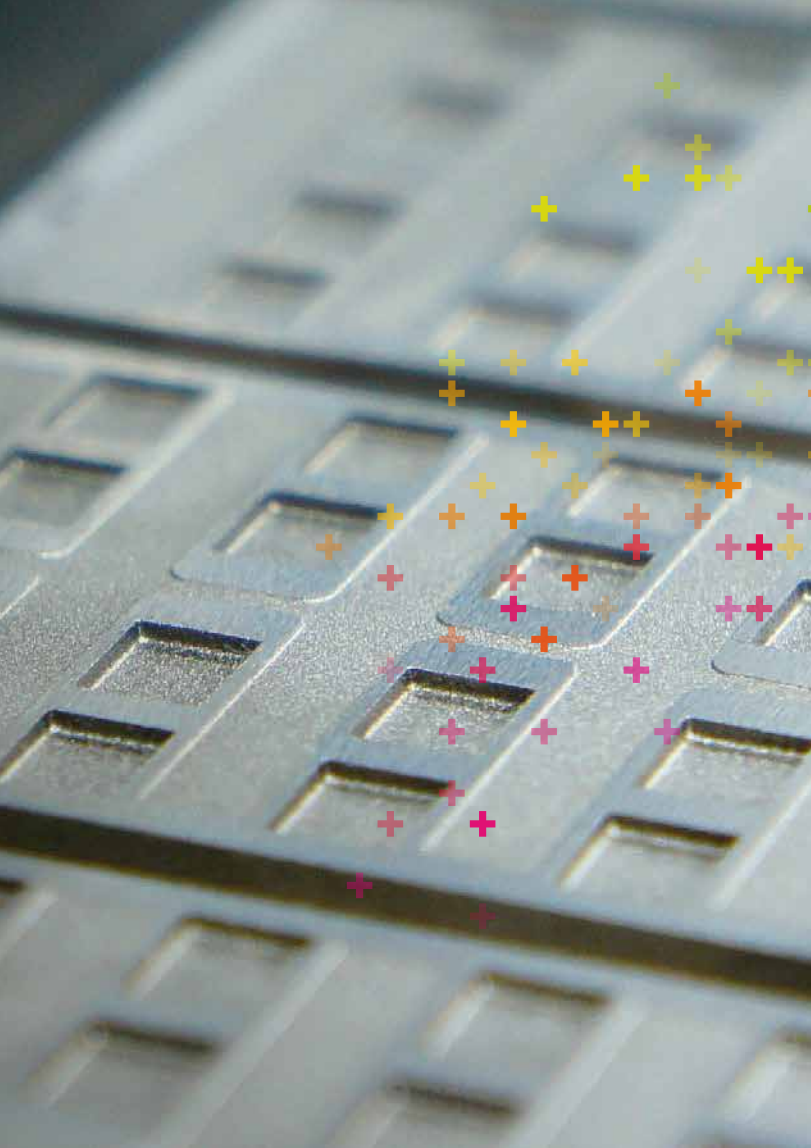

### Enhance your injection results with 3DS mold surface texturing

Your surface texturing reaches a new level of perfection, thanks to GF Machining Solutions' new three-dimensional surface (3DS) texturing technology enabled by our Intelligent Speed Power Generator (ISPG).



### Reduce electrode and workpiece setup time

Your success in reducing unproductive time is linked to the alignment of your first workpiece and electrode. Avoid manual operations, save time, and gain productivity with the available C-axis.



### Increase autonomy without manual intervention

Manufacturing a mold often requires a large number of electrodes whose spark erosion time can significantly vary from one cavity to another. The FORM S 350 machines have a rotary changer boasting storage capacity for up to 160 electrodes. A double gripper-clamp reduces unnecessary movement to appreciably speed up the loading process.

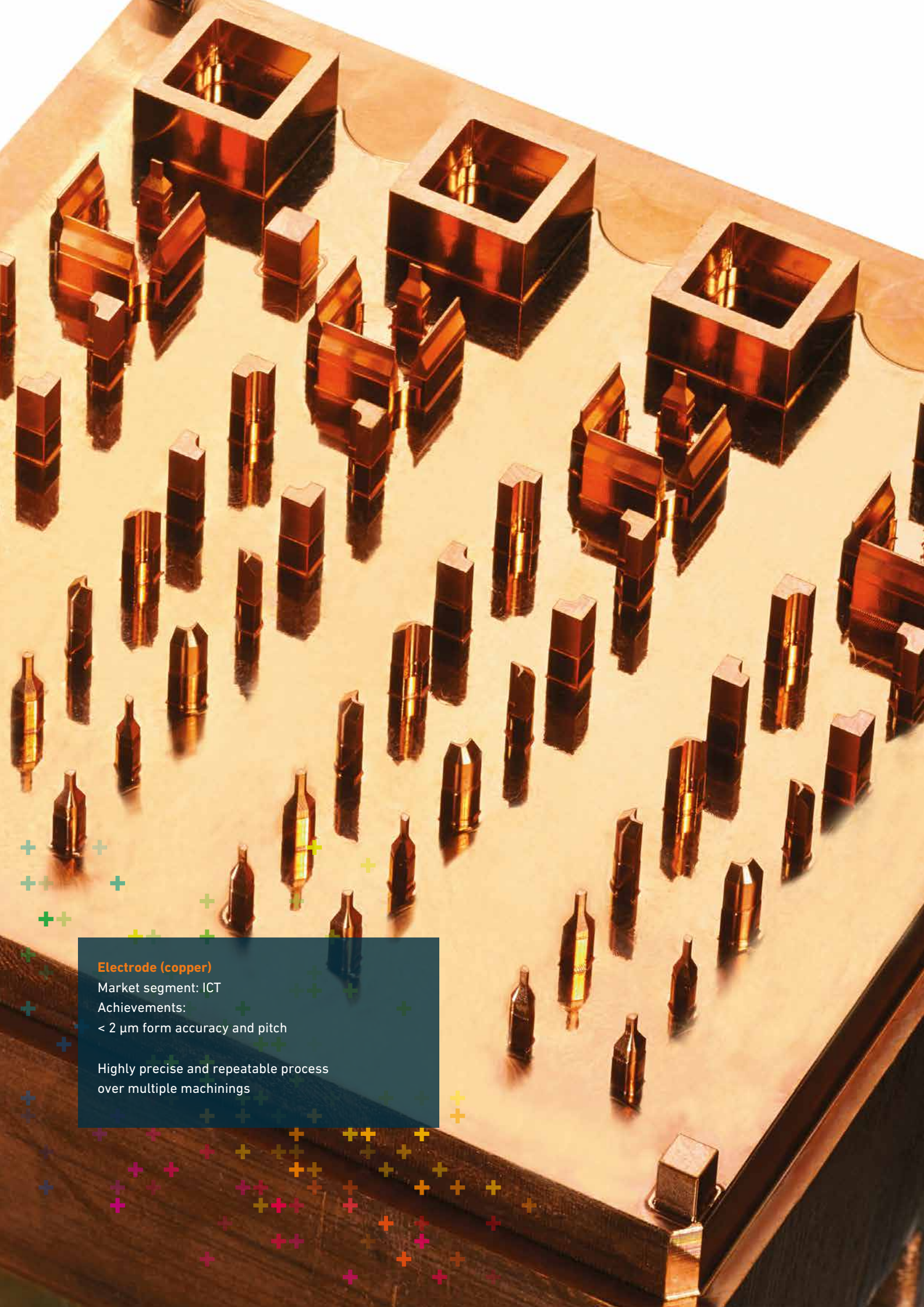

**Electrode (copper)**

Market segment: ICT

Achievements:

< 2  $\mu\text{m}$  form accuracy and pitch

Highly precise and repeatable process  
over multiple machinings



The right Milling solution

# Your one-source solutions provider

Wherever you are in the world, it's a big plus to be have one partner as a single-source provider of machining technologies, products and services. GF Machining Solutions is the one partner with the expertise to optimize your global processes with solutions adapted to your electrode machining needs.



MILL S 400 U

## A perfect fit in your process chain

Machine copper and graphite electrodes with high accuracy in preparation for the subsequent EDM process with GF Machining Solutions MILL S 400 U. At the same time, experience a solution that fits perfectly into your manufacturing process chain.

## Unique benefits for you

- Master the challenge of delivering speed and quality at the highest level
- Solution for copper and graphite (wet or dry) in one machine
- Unbeatable flexibility in three- and five-axis applications
- Highest productivity per square meter with Automation

## The best results are the best arguments.

The MILL S 400 U is suited for small, accurate parts because of its combination of linear drives with high dynamics, a 42,000 rpm Spindle, and a stiff, thermal-stabilized machine body.

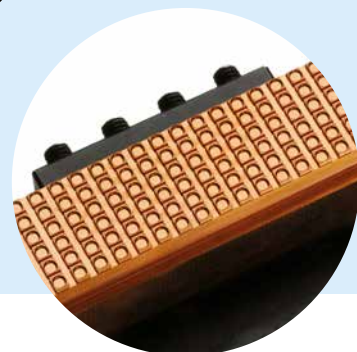

Higher degree of autonomy

# Tooling and Automation to drive your productivity

Experience always shows that measures to reduce the idle times of your machines are significantly more worthwhile than chasing seconds in the actual machining process. The solution is a stable and exact System 3R reference system. This lets you preset away from the machine and then set up the machine with minimum idle time. Quickly and precisely.

## Boost your competitiveness

Automation keeps production going whatever the time of day or day of the week. Your results are shorter lead times, higher productivity and quicker payback of capital invested in machines. With automated operations, production can continue running round the clock, seven days a week. The possibilities are endless.

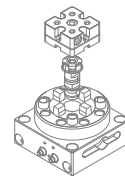
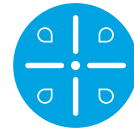

Macro

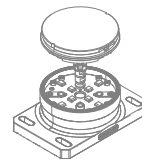

MacroMagnum

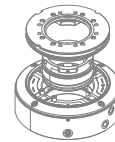

Matrix

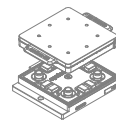

Dynafix

## Customer Services

# Accelerate your production to new levels of success

Experience the highest performance of your equipment with GF Machining Solutions Customer Services providing you with unbeatable life cycle support.



### Keep pace in a changing environment

As your business evolves, so does its needs, and you can count on GF Machining Solutions for the individually tailored solutions to enhance your operational excellence. We help you keep pace with the continuously changing business and market environments and outperform your competitors.



### Operations Support: solutions to boost your applications

Your-single source provider of a vast selection of certified consumables including electrodes and filters to achieve optimum level of performance.



### Machine support: securing your sustainable machining success

Preventive maintenance as well as advanced preventive services such as circularity tests with ball bar or laser calibration will optimize your uptime.



### Business support: realize the full potential of your equipment

Advanced support and consulting—including training, upgrades and dedicated Automation solutions—to improve your performance, productivity and competitive edge.

## Technical specifications

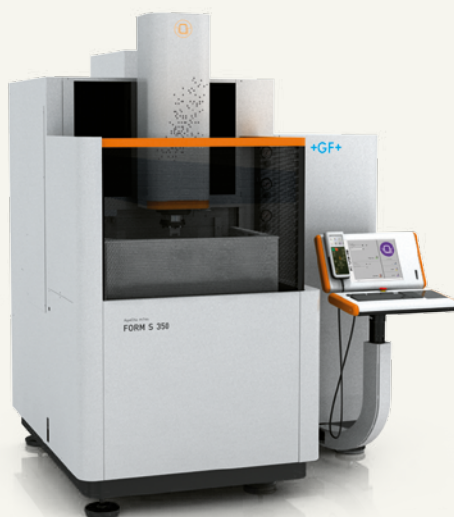

### FORM S 350

#### FORM S 350

##### Equipment

Dimensions (*)	mm (in)	1900 x 1690 x 2650 (74.80 x 66.53 x 104.33)
Total weight	kg (lbs)	2800 (6173)

##### Work area

Max. workpiece dimensions (*)	mm (in)	790 x 530 x 300 (31.1 x 20.87 x 11.81)
Max. workpiece weight	kg (lbs)	500 (1102.31)
Worktable size (**)	mm (in)	500 x 400 (19.68 x 15.75)

##### X, Y, Z axes

X, Y, Z travel (*)	mm (in)	350 x 250 x 300 (13.78 x 9.84 x 11.81)
Max. manual displacement speed	m/min (ft/min)	6 (19.7)
Max. machining speed (XY)-(Z)	m/min (ft/min)	6-15 (19.7-49.2)
Max. machining acceleration (XY)-(Z)	m/s <sup>2</sup> (ft/s <sup>2</sup> )	2.5-5 (8.2-16.4)
Lubrication		Automatic centralized

##### Eco C-axis (\*\*\*)

Max. rotation speed	rpm	1 to 100
C-axis max. electrode inertia	kgcm <sup>2</sup> (lbsin <sup>2</sup> )	2000 (680)
Max. electrode weight	kg (lbs)	50
Positioning resolution	°	0.05

##### Accura C-Axis (\*\*\*)

Max. rotation speed	rpm	1 to 100
C-axis max. electrode inertia	kgcm <sup>2</sup> (lbsin <sup>2</sup> )	5000 (1700)
Max. electrode weight	kg (lbs)	50
Positioning resolution	°	0.05

\* Width x depth x height \*\* Width x depth \*\*\* Option

## FORM S 350

### High speed generator

Generator		ISPG
Machining current	A	80, 140 ***
iQ module (no wear)		Standard
Minimum surface finish	µm Ra	0.08

### Numerical control

Measurement device (XYZ)		Linear scales
Measurement resolution (XYZ)	µm (in)	0.05 (0.000002)
Operating system		Windows
Screen		15" TFT Color (touch screen)
Communication ports		PCMCIA Port, Ethernet RJ45, USB (x2)
Restart after power failure		No
Programming system on PC		Standard
Smart modules		No

### Options

Linear Tool Changer	pos.	4-5
Rotary Tool Changer	pos.	16-160
Ready for automation		Yes
Connectivity		e-connect, e-control, e-monitoring
Multicavities flushing		6 outputs

\*\*\* Option

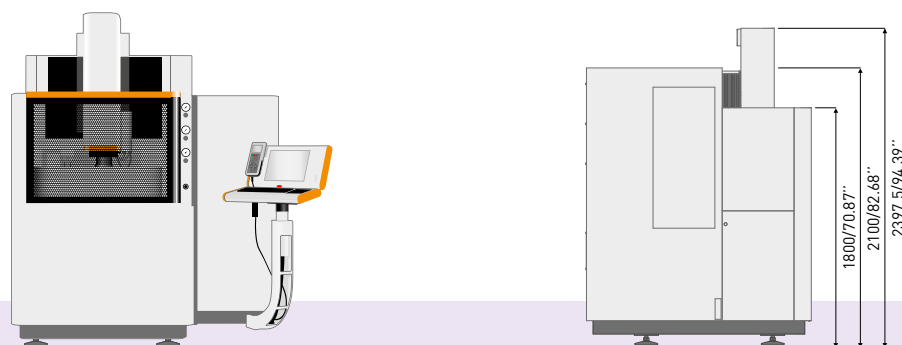

**FORM S 350**

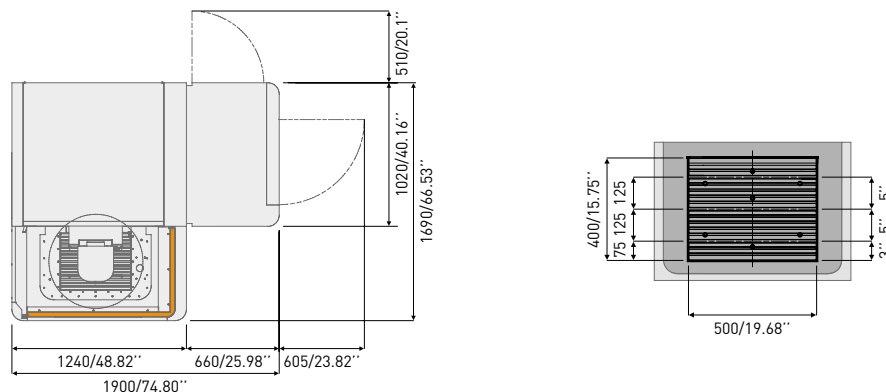

# GF Machining Solutions



## EDM (electrical discharge machining)

### AgieCharmilles wire-cutting, die-sinking and hole-drilling machines

For over 60 years we have been at the forefront of every EDM development: designing and refining the EDM process and building machine tools that deliver peerless part accuracies, surface finishes, cutting speeds and process reliability. Today, our AgieCharmilles wire-cutting, die-sinking and hole-drilling machines are recognized throughout the world as the best in the business. Our continuous research and development in digital generator technology, control systems and integrated Automation systems are evidence of our commitment to keeping your EDM operations on the leading edge of technology.



## Laser

### AgieCharmilles Laser texturing machines

Laser texturing is a fully-digitized surface engineering process that has huge potential. The technology enables precise 2D and 3D textures or engravings to be machined accurately and directly onto complex parts or molds to improve and alter their aesthetic appeal, functionality and performance. The process is infinitely repeatable and offers many distinct environmental and economic advantages over conventional texturing processes.

### Laser Additive Manufacturing (AM)

GF Machining Solutions has partnered with EOS, the global leader for high-end AM solutions, to integrate this innovative technology and further develop it into its current solutions to fully benefit the mold industry, by focusing on injection efficiency: optimized cooling design to reduce cycle time, lower energy consumption, higher quality of plastic parts.



## Tooling and Automation

### System 3R Tooling, Automation and software

Productivity is the key to manufacturing success, and automating a manufacturing process is a proven method of increasing its efficiency, effectiveness, quality and reliability. System 3R's integrated Tooling, Automation and software solutions ranging from simple workpiece pallet and electrode changers through to flexible manufacturing and robot handling systems are guaranteed to help you increase their competitive advantage.



## Milling

### Mikron MILL S (high-speed Milling), Mikron MILL P (high-performance Milling) and Mikron MILL E (high-efficiency Milling)

Customers operating in the mold, tool and die and precision component manufacturing sectors stake their reputations on being able to quickly and cost-competitively meet their customers' demands. That's why they invest in GF Mikron machines. Incorporating the latest and most advanced technologies and premium-performance components, Mikron MILL S, Mikron MILL P and Mikron MILL E machines help you increase your production capabilities and improve your productivity. Designed and built for speed, accuracy and reliability, the machines, like you, are proven performers.

### Liechti dedicated aerospace and energy machining centers

Aerospace and power generation turbine manufacturers increasingly turn to Liechti dedicated five- and six-axis machining centers to machine complex, high-precision airfoils on blades, disks, blings, blisks/IBRs and impellers. It's easy to see why because these machines, with their specific profile machining technology, specialized CAD/CAM software and engineering competence for ultra-dynamic machining in titanium, Inconel, nimonic, titanium-aluminide and high-alloy steels, yield productivity gains as much as 30 percent, thanks to reduced machining times. In the globally competitive aerospace and power generation manufacturing sector, that's definitely worth shouting about.

### Step-Tec Spindles

At the heart of every GF Mikron machining center is high-performance Step-Tec Spindle. Step-Tec Spindles are essential core components of our machining centers. Highly accurate and thermally stable Step-Tec Spindles ensure that our machines can handle everything from heavy-duty roughing to fine-finishing operations.



## Customer Services

### Operations Support, Machine Support and Business Support

To help you get the most and the best from your machine tools and equipment, we offer three levels of support. Operations Support covers our range of original wear parts and certified consumables (EDM wires, filters, resins, electrodes etc.) to ensure that your machines are performing at the highest levels. Machine Support maximizes, through our best-in-class technical support, preventive services and quality spare parts, your machine tool uptime. Business Support is designed to help you make a real step-change in your productivity and performance with solutions tailored to your specific needs.



## At a glance

We enable our customers to run their businesses efficiently and effectively by offering innovative Milling, EDM, Laser, Additive Manufacturing, Spindle, Tooling and Automation solutions. A comprehensive package of Customer Services completes our proposition.

[www.gfms.com](http://www.gfms.com)

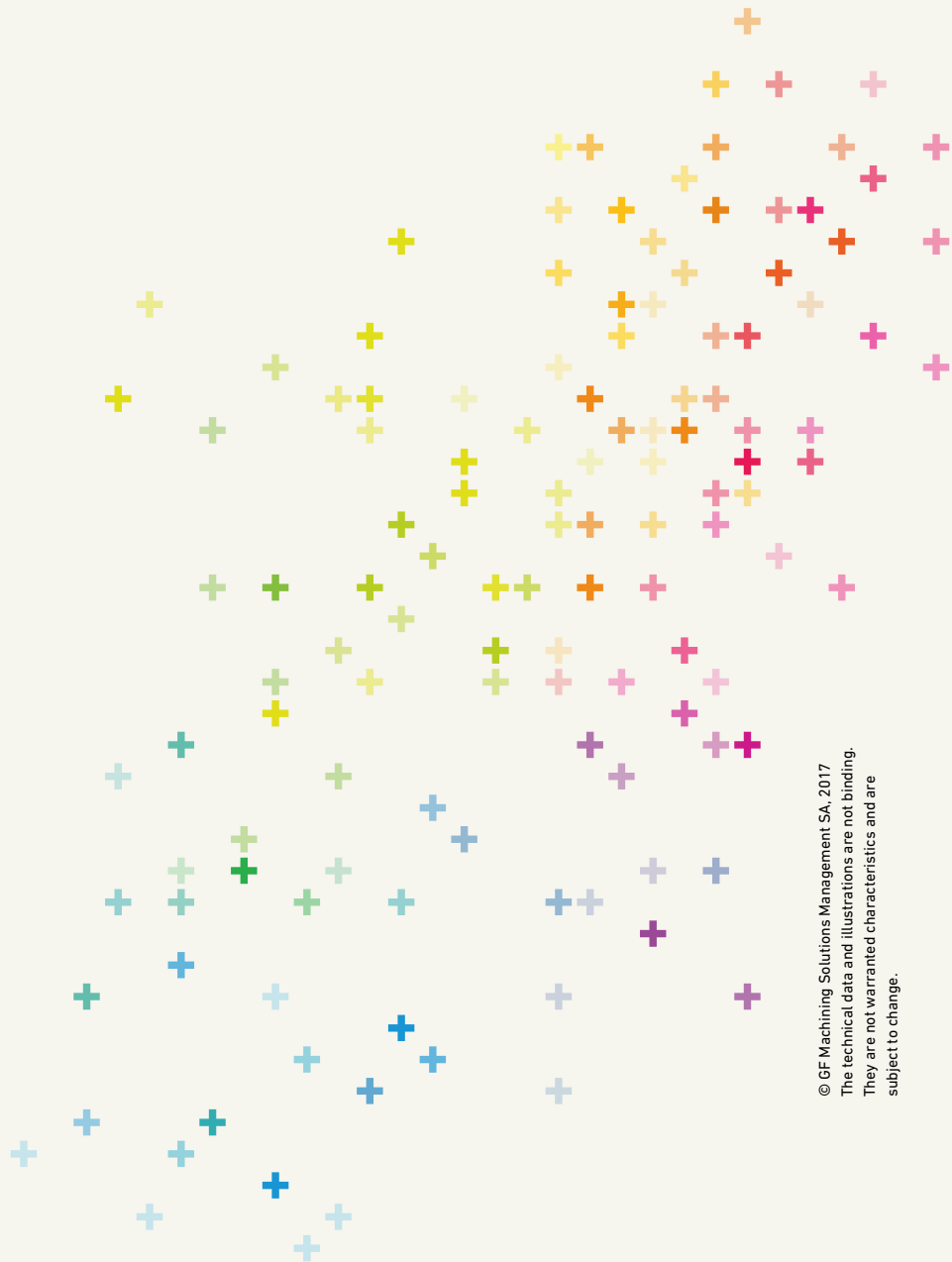

© GF Machining Solutions Management SA, 2017  
The technical data and illustrations are not binding.  
They are not warranted characteristics and are  
subject to change.